



ECP2000C with two SR25.2-W peristaltic pumps

## Peltier Gas Cooler Series ECP®

Version ECP1000C with 1 x 150 NI/h

Version ECP2000C with 2 x 150 NI/h

Version ECP3000C with 1 x 350 NI/h

### Special Features

- Ambient temperature from +5 to +50 °C [41 to 122 °F] (no extra charge)
- Outlet dew point adjustable from +2 to +15 °C [35.6 °F to 59 °F]
- Dew point stability  $\pm 0.1$  °C [ $\pm 0.18$  °F]
- Control setpoint selectable between: absolute value mode or  $\Delta T$  mode
- Optional measurement of the gas outlet temperature in the gas path
- Ready for use in less than 3 minutes
- Option: configurable mA output (no shielding necessary)
- Integrated evaluation for liquid alarm sensors type LA1 or LA1S
- Configurable, potential-free alarm output
- Universal power supply
- Mounting option for up to two SR25.2-W peristaltic pumps below the unit
- Compact design, low weight
- Jet-Stream heat exchangers available in various materials
- Compatible with previous version

### Application

The M&C gas coolers of the ECP® series are used in analytical technology to reduce the dew point of humid gases in order to prevent condensation in the analyzer. By setting an extremely stable gas outlet dew point, water vapor cross-sensitivities and volumetric errors are minimized.

The compact, lightweight design makes the ECPX000C units particularly suitable for portable and compact stationary gas conditioning systems.

### Description

With the upgraded version ECPX000C, M&C combines the solid advantages of the ECPX000 devices with new future-oriented features, a significant increase in cooling capacity, more functions and improved service friendliness.

The ECPX000C gas cooler can be operated at ambient temperatures of up to 50 °C [122 °F] as standard.

It is characterized by a very high dew point stability of  $< \pm 0.1$  °C [ $\pm 0.18$  °F].

The broadband power supply makes the cooler universally usable. Plug-in electrical connections for power and alarm relays are standard. The connections of the configurable mA outputs (optional) are also supplied as plug-in versions.

The ECPX000C is equipped with a wear-free, capacitive control and display panel for improved handling of the cooler.

The absolute value control implemented by the previous ECPX000 version has been extended by the differential temperature mode.

The cooling capacity has almost doubled compared to the previous version. The ECPX000C gas cooler is ready for use in less than 3 minutes under normal operating conditions.

The housings of the three ECPX000C devices have the same compact dimensions and are compatible with previous versions.

The units can be opened from the front for easier maintenance.

The condensate can be discharged externally by peristaltic pumps, traps or collecting vessels. Up to two peristaltic pumps for condensate removal can be mounted directly below the unit.

## Dimensions



### ECP1000C/2000C/3000C\*

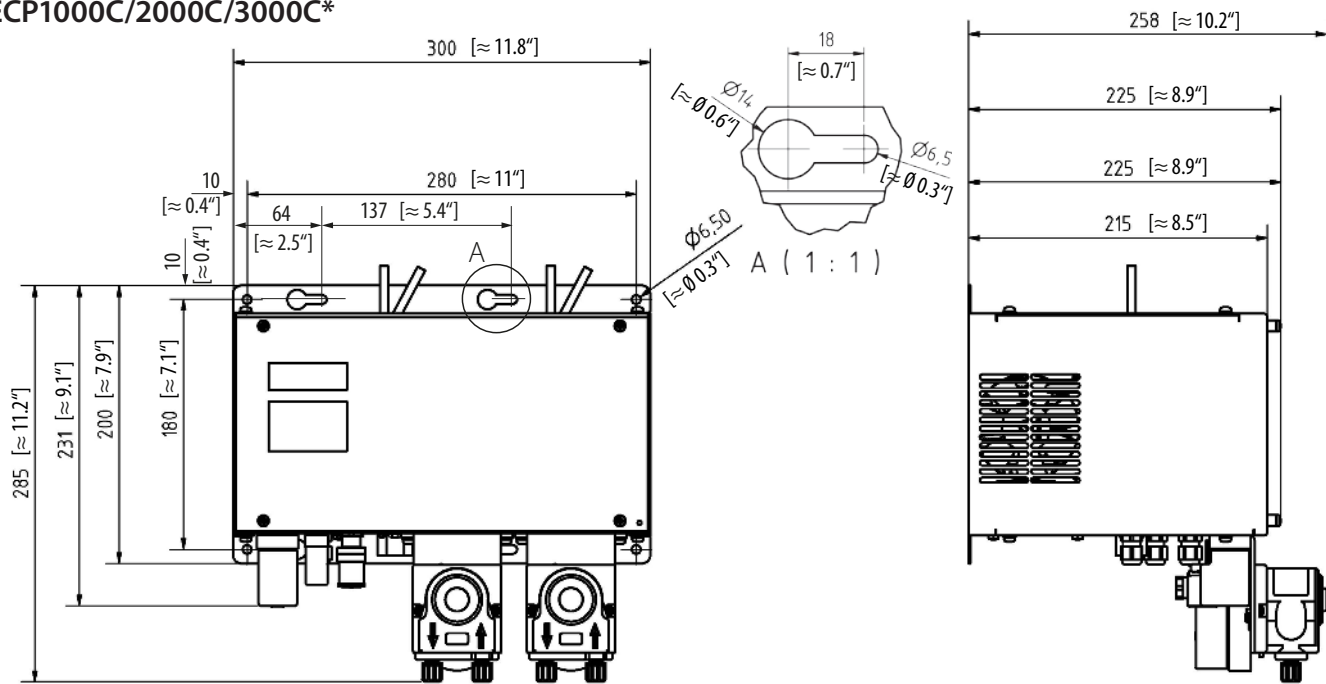

\* Drawing shows ECP2000C with two optional SR25.2-W peristaltic pumps  
Dimensions in mm [inches]

### Application example for ECP1000C/ECP3000C

- 1 Gas sample probe SP180-H or SP2000-H
- 2 Heated sample line 4M4/6
- 3 Gas cooler ECP1000C/ECP3000C
- 4 3-way ball valve 3L/PV-1
- 5 Peristaltic pump SR25.2-W
- 6 Diaphragm pump MPF-05 or MP06/12 or N5KP
- 7 Universal filter FP-2T-D with liquid alarm type LA1
- 8 Aerosol filter CLF-5/W optional according to application
- 9 Flow meter FM10 or FM40, 25-250 NI/h
- 10 Analyzers e.g. GENTWO PMA1000 V2.2

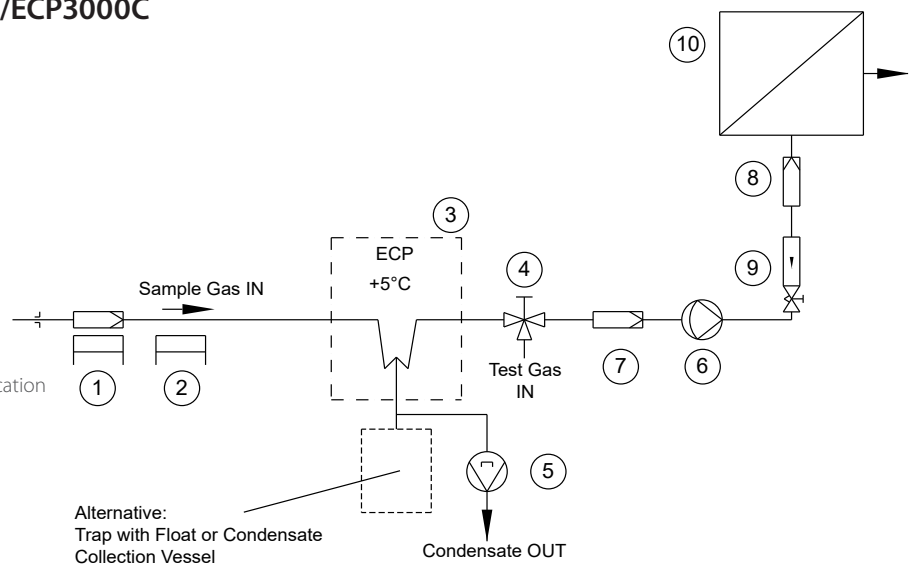

### Technical Data

Gas Cooler Series EC*	ECP1000C	ECP2000C	ECP3000C
Part No. without heat exchangers	01K1400x	01K2400x	01K3400x
Number of possible heat exchangers	1	2	1
Gas flow rate per heat exchanger	Max. 150 NI/h*	2 x max. 150 NI/h*	Max. 350 NI/h*
Ambient temperature	+5 to +50 °C [41 to 122 °F]		
Storage temperature	-20 to +60 °C [-4 to 140 °F]		
Sample outlet dew point	Range of adjustment: +2 to +15 °C [35.6 to 59 °F], factory setting: +5 °C [41 °F]		
Dew point stability	±0.1 °C [±0.18 °F] at constant conditions		
Sample inlet temperature	Max. 180 °C [356 °F]*		
Gas inlet water vapor saturation	Max. 80 °C [176 °F]*		
Total cooling capacity at +25 °C ambient	110 kJ/h	2 x 90 kJ/h	110 kJ/h
Δ P per heat exchanger at	1 mbar at 150 NI/h	1 mbar at 150 NI/h	5 mbar at 350 NI/h
Stagnant space per heat exchanger	50 ml	2 x 50 ml	100 ml
Power consumption	150 VA	275 VA	150 VA
Power supply	115 - 230 V AC ±10 %, 50/60 Hz		

Gas Cooler Series EC*	ECP1000C	ECP2000C	ECP3000C
Part No. without heat exchangers	01K1400x	01K2400x	01K3400x
Ready for use	< 3 min. (at 25 °C [77 °F] ambient temperature and with no load applied)		
Max. loudness	58 dBA		
Electrical connection	Power: pluggable via solenoid valve plug type A Alarm relay: pluggable via solenoid valve plug type B mA: when purchasing the mA option, pluggable via Phoenix circular connector 1681101		
Signal input and output	One mA output per channel possible (no shielding required) One M&C LA liquid alarm sensor type LA1 or LA1S can be connected per channel. The evaluation is integrated as standard.		
Status alarm: 2 changeover contacts	Contact rating: 250 V, 2 A, 500 VA, 50 W		
Case protection	IP20; EN 60529		
Electrical standard	EN 61010		
EMC standard	EN 61326		
Case color	RAL 9003		
Method of mounting	Wall-mount		
Case dimensions (W x H x D)	300 x 200 x 225 mm [≈ 11.8" x 7.9" x 8.9"]		
Weight without heat exchangers	6.5 kg [≈ 14.3 lbs.]	8.2 kg [≈ 18.1 lbs.]	6.7 kg [≈ 14.8 lbs.]

\* Maximum values in technical data must be rated in consideration of total cooling capacity at 25 °C [77 °F] ambient temperature and an outlet dew point of 5 °C [41 °F]. Please note: NI/h and NI/min refer to the German standard DIN 1343 and are based on these standard conditions: 0 °C [32 °F], 1013 mbar.

## Heat Exchanger Options

Gas Cooler Series ECP®	ECP1000C/ECP2000C				
Heat exchanger type	ECM-2/ ECP(1/2)000C/ ECC-1 G, WT	ECM-2/ ECP(1/2)000C/ ECC-1 PV, WT	ECM-2/ ECP(1/2)000C/ ECC-1 SS, WT	ECM-2/ ECP(1/2)000C/ ECC-1 SS/NPT, WT	ECM-2/ ECP(1/2)000C/ ECC-1 G/GL14, WT
Part No.	97K0100	97K0110	97K0115	97K0115NN	97K0101
Material of heat exchanger	DURAN® glass	PVDF	SS 316Ti	SS 316Ti	DURAN® glass
Admissible gas pressure	Max. 3 bar abs. <sup>1)</sup> (2 bar abs. <sup>2)</sup> )	Max. 3 bar abs. (2 bar abs. <sup>2)</sup> )	Max. 10 bar abs. (2 bar abs. <sup>2)</sup> )	Max. 10 bar abs. (2 bar abs. <sup>2)</sup> )	Max. 3 bar abs. <sup>1)</sup> (2 bar abs. <sup>2)</sup> )
Sample gas connection	GL 18 for tube Ø 6 mm OD	Tube Ø 6 mm	Tube Ø 6 mm	1/4" tube	GL 18 for tube Ø 6 mm OD; GL 14 for sensor
Condensate connection	GL 25 for tube Ø 12 mm, Ø 8 mm* or Ø 10 mm*	G 3/8"i	G 3/8"i	3/8" NPT	GL 25 for tube Ø 12 mm, Ø 8 mm* or Ø 10 mm*

Gas Cooler Series ECP®	ECP3000C			
Heat exchanger type	ECM-1/ECP3000(C)/ ECC-1 G, WT	ECM-1/ECP3000(C)/ ECC-1 PV, WT	ECM-1/ECP3000(C)/ ECC-1 SS, WT	ECM-1/ECP3000(C)/ ECC-1 SS/NPT, WT
Part No.	93K0140	93K0170	93K0160	93K0160N
Material of heat exchanger	DURAN® glass	PVDF	SS 316Ti	SS 316Ti
Admissible gas pressure	Max. 3 bar abs. <sup>1)</sup> (2 bar abs. <sup>2)</sup> )	Max. 3 bar abs. (2 bar abs. <sup>2)</sup> )	Max. 10 bar abs. (2 bar abs. <sup>2)</sup> )	Max. 10 bar abs. (2 bar abs. <sup>2)</sup> )
Sample gas connection	GL 18 for tube Ø 6 mm OD	G 1/4" i	G 1/4" i	1/4" NPT
Condensate connection	GL 25 for tube Ø 12 mm, Ø 8 mm* or Ø 10 mm*	G 3/8" i	G 3/8" i	3/8" NPT

\* Optional

<sup>1)</sup> With GL adapter

<sup>2)</sup> With peristaltic pump SR25.2-W

GL adapter and tube fittings for the connection of different tube diameters at the heat exchanger, see data sheets "Fittings for GL Glass Connections" and "Flexible and rigid tube fittings, plugs and connectors with barbed fitting".

DURAN® is a brand name for borosilicate glass produced by the German company DURAN Group GmbH.

## More Options

Options für ECPX000C	
Part No. 01K9200	1 x mA output incl. plug and socket, mounting and calibration (per channel)
Part No. 01K9250	1 x thermocouple incl. plug, socket, signal converter and mounting incl. special heat exchanger with three gas connections (ECP1000C only)
Part No. 01K9260	Type LA1S: Liquid alarm sensor with cable break detection Note: Evaluation is carried out as standard in the ECPX000C, LA1S for M&C universal filters with D connection
Part No. 01K9270	Type LA1: Liquid alarm sensor without cable break detection Note: Evaluation is carried out as standard in the ECPX000C, LA1 for M&C universal filters with D connection
Part No. 01P1307	Peristaltic pump SR25.2-W, 0.3 NI/h, 115/230 V AC with PVDF tube connection fitting DN 4/6 mm
Part No. 01P9160X	SR25.2-W Connection set without peristaltic pump (PVDF screw connections for SS 316Ti, PVDF and glass HE, 0.5 m Novoprene hose and fixing screws)

# Cooling Capacity

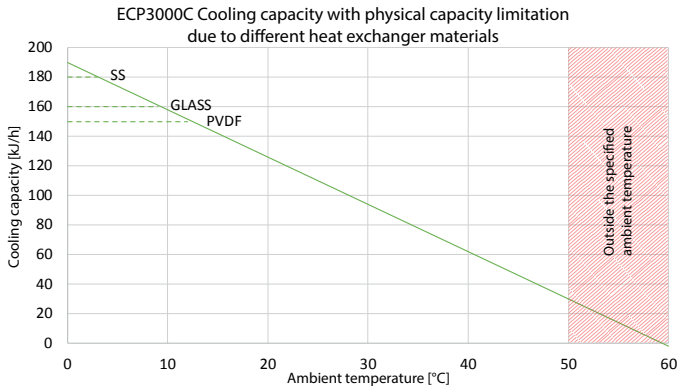
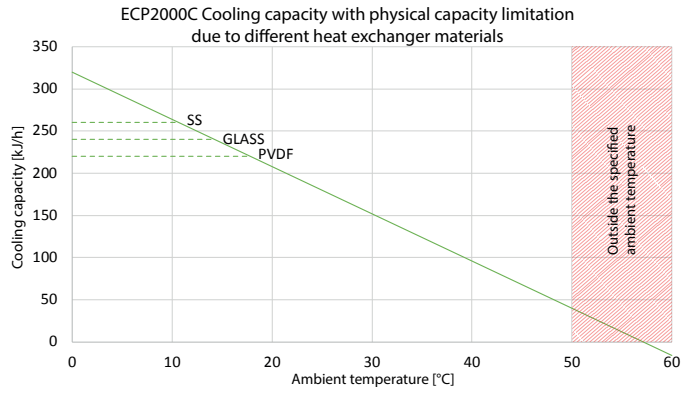
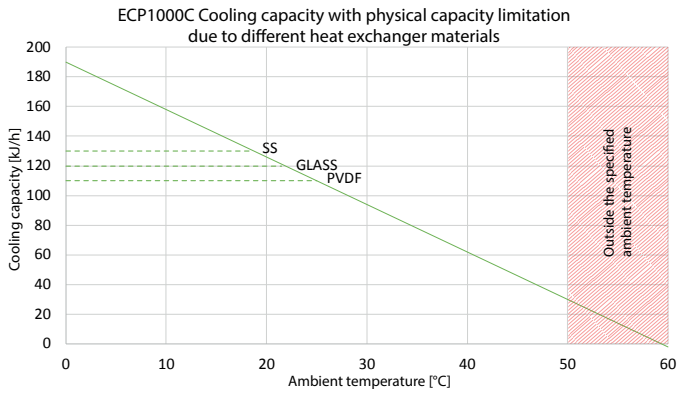

# Maximum Inlet Dew Point

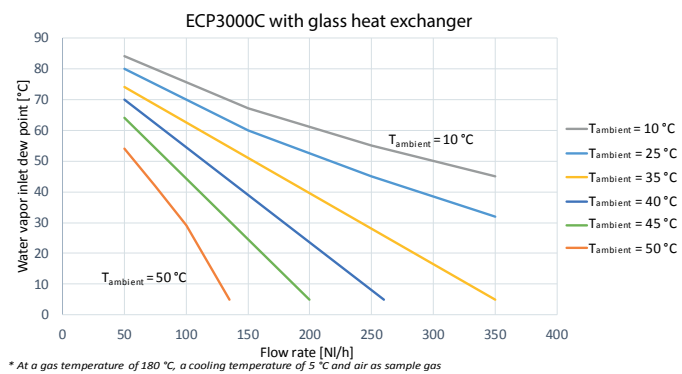
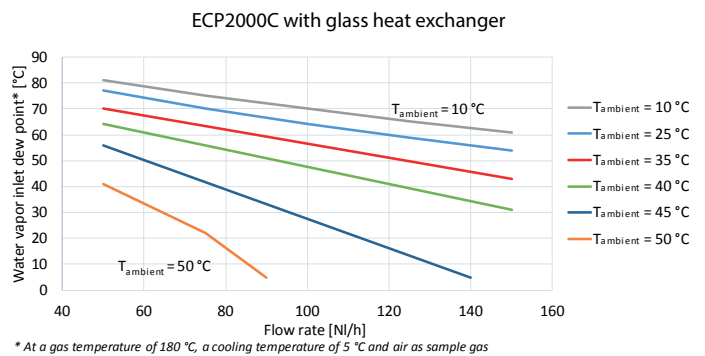
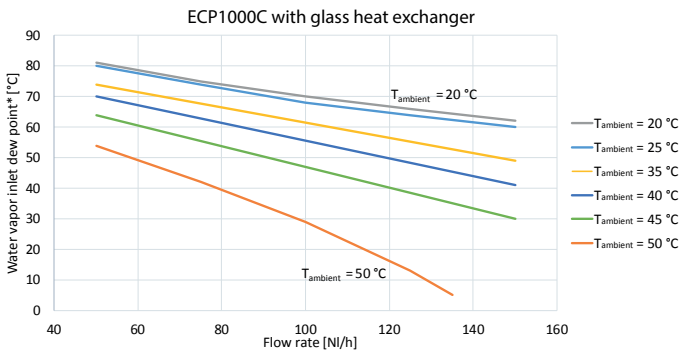

# Gas Outlet Dew Point

